

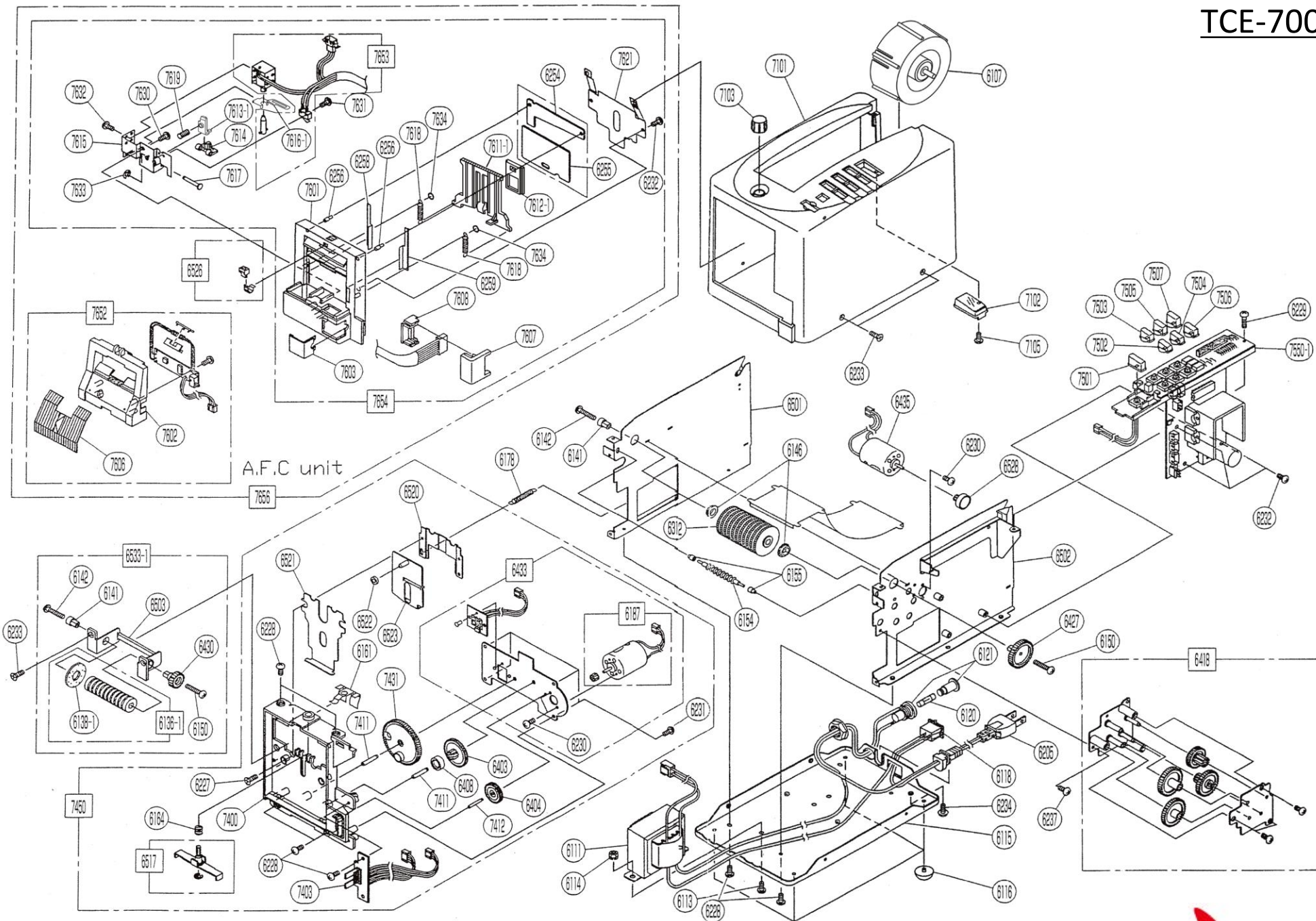





























TCE-700





部品番号 Parts No.	部品名 Parts Name	略図 llust	定価 Price	備考 Ncte	重さ Weight
7101	本体カバー		¥2,500-		309g
7102	フィルター		¥120-		1.6g
7103	プレッシャーつまみ		¥120-		1.8g
7105	タップタイトねじ		¥15-	B3×6mm フィルター用	0.5g
6107	トリプルリールユニット		¥700-	TCE700 -60031	40g
6108	1インチリール		¥800-		48g
6111	トランス 100V		¥3,000-		520g
6113	小ねじナベ		¥15-	4×8mm	1g
6114	ワッシャ付きナット		¥30-	4mm	3g
6115	底板		¥670-		260g
6116	足ゴムユニット		¥70-		2g











部品番号 Parts No.	部品名 Parts Name	略図 llust	定価 Price	備考 Note	重さ Weight
6118	パワースイッチ		¥420-		5g
6120	ヒューズ		¥110-		2g
6121	ヒューズホルダー		¥600-		6g
6136-1	剥離ローラーユニット (新)		¥900-	TCE700 -60042	60g
6138-1	剥離ローラーリング (新)		¥70-	TCE700 -60041	2g
6141	ローラー軸		¥50-		2g
6142	タッピンナベ		¥15-	3×20mm	1g
6146	軸受け		¥35-		1g
6150	タッピンナベ		¥20-	3×25mm	1g
6154	押さえローラー		¥260-		10g
6155	押さえローラーカラー		¥50-		1g

部品番号 Parts No.	部品名 Parts Name	略図 ■ust	定価 Price	備考 Note	重さ Weight
6161	カッターホルダー スプリング		¥85-		2g
6164	ラベル押さえ スプリング		¥50-		2g
6178	アーススプリング		¥50-		2g
6187	カットモーターユニット		¥1,660-		62g
6205	コード (国内用)		¥500-		68g
6227	タップタイトナベ		¥20-	3x8mm	1g
6228	タップタイトナベ		¥20-	3x8mm	1g
6229	タッピンナベ		¥30-	3x14mm	1g
6230	小ねじナベ		¥20-	2.6x3mm	1g
6231	タッピンナベ		¥20-	3x10Amm	1g
6232	小ねじナベ		¥20-	3x5mm	1g



部品番号 Parts No.	部品名 Parts Name	略図 ■ust	定価 Price	備考 Note	重さ Weight
6233	タップタイト丸皿		¥30-	3x8mm	1g
6234	タッピンナベ座付き		¥20-	3x8mm	1g
6237	タップタイトナベ		¥20-	3x5mm	1g
6254	カッター1		¥4,000- (セット)	TCE700 -60030	42g
6255	カッター2				
6256	カッター止めシャフト		¥50-		2g
6258	カッターライナー右		¥50-		1g
6259	カッターライナー左		¥50-		1g
6289	シリコンオイル		¥340-	TCE700 -60023	5g
6290	包装袋		¥25-		6.5g
6296	定格ラベル (和文)		¥80-		0.7g







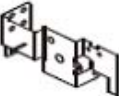



部品番号 Parts No.	部品名 Parts Name	略図 Must	定価 Price	備考 Note	重さ Weight
6304	ON・OFFラベル		¥60-		0,06 g
6312	送りローラー(新)		¥650-		186 g
<u>7400</u>	前面ホルダー(新)		¥400-		44,3 g
<u>7403</u>	前面コネクター2		¥800-		7,6 g
6403	平歯車15		¥130-		5 g
6404	平歯車16		¥130-		2 g
6408	カラ-2		¥100-		6 g
<u>7411</u>	平歯車軸21		¥60-		1 g
<u>7412</u>	平歯車軸22		¥60-		1,5 g
6418	ギア取付板ユニット		¥1,350-	TCE700-641815	90 g
6427	送りローラーギヤ(新)		¥170-		5 g

部品番号 Parts No.	部品名 Parts Name	略図 Must	定価 Price	備考 Note	重さ Weight
6430	剥離ローラーギヤ		¥170-		2 g
<u>7431</u>	カッターギヤユニット2		¥670-		12 g
6433	カッター部ギヤカバー2 ユニット		¥2,500-	TCE700-643315	105 g
6435	送りモーターユニット		¥1,500-	TCE700-6435	75 g
<u>7450</u>	前面ホルダーユニット		¥5,500-	TCE700-745015	300 g
6501	側板2左ユニット		¥500-		155 g
<u>7501</u>	オートボタン		¥70-		0,8 g
6502	側板3右ユニット		¥840-		175 g
6503	剥離ローラーホルダー		¥170-		5 g
<u>7502</u>	スイッチボタン1		¥70-		0,5 g
<u>7503</u>	スイッチボタン2		¥70-		0,5 g

部品番号 Parts No.	部品名 Parts Name	略図 llust	定価 Price	備考 Note	重さ Weight
<u>7504</u>	スイッチボタン3		¥70-		0.6g
<u>7505</u>	スイッチボタン4		¥70-		0.6g
<u>7506</u>	スイッチボタン5		¥70-		0.7g
<u>7507</u>	スイッチボタン6		¥70-		0.7g
6517	ローラー押さえユニット		¥340-		15g
6520	カットレバー押さえ		¥170-		10g
6521	カットレバーライナー2		¥170-		20g
6522	カットレバーシャフト カラー		¥50-		2g
6523	カットレバー2ユニット		¥100-		23g
6526	オープンセット		¥170-		8g
6528	ビニオンギヤ2ユニット		¥590-		10g

部品番号 Parts No.	部品名 Parts Name	略図 llust	定価 Price	備考 Note	重さ Weight
6533-1	剥離ローラーホルダー ユニット (新)		¥1,400-	TCE700 -60043	66g
6535	アタッチメント		¥5,500-		
<u>7550-1</u>	制御盤ユニット2		¥22,000-		137g
<u>7601</u>	カッターホルダー		¥350-		44.8g
<u>7602</u>	センサーカバー		¥250-		14g
<u>7603</u>	コネクタリード		¥70-		2g
<u>7606</u>	密着防止カバー		¥600-		4.7g
<u>7607</u>	コネクタ-3		¥70-		3.1g
<u>7608</u>	コネクタ-4		¥70-		2.4g
<u>7611-1</u>	シャッター-2		¥200-		9.1g
<u>7612-1</u>	スライダー-2		¥120-		1.8g

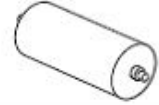
部品番号 Parts No.	部品名 Parts Name	略図 ■ust	定価 Price	備考 Note	重さ Weight
<u>7613-1</u>	ストッパー-2		¥120-		0.6 g
<u>7614</u>	リムーバー		¥120-		0.7 g
<u>7615</u>	ブラケット		¥150-		11.1 g
<u>7616-1</u>	ムーバー-2		¥120-		2.5 g
<u>7617</u>	ストッパーシャフト		¥40-		3 g
<u>7618</u>	シャッター Springs		¥120-		0.7 g
<u>7619</u>	リターン Springs		¥80-		0.2 g
<u>7621</u>	カッター Springs		¥200-		12.5 g
<u>7630</u>	タップタイトねじ		¥30-	B3×8mm ブラケット用	1 g
<u>7631</u>	タップタイトねじ		¥30-	B2×10mm マイクロスイッチ用	1 g
<u>7632</u>	十字穴付きねじ		¥30-	M2.6×3mm ソレノイド用	1 g

部品番号 Parts No.	部品名 Parts Name	略図 ■ust	定価 Price	備考 Note	重さ Weight
<u>7633</u>	Eリング		¥20-	ストッパー シャフト用	0.1 g
<u>7634</u>	Oリング 抜け止め		¥20-		0.1 g
<u>7652</u>	センサーユニット		¥8,500-	TCE700 -7652	21 g
<u>7653</u>	新ソレノイドユニット		¥4,000-	TCE700 -7653	22.2 g
<u>7654</u>	カッターホルダー ユニット		¥8,500-	TCE700 -7654	153 g
<u>7656</u>	オートフィードカッター ユニット		¥17,000-	TCE700 -AFCU	184.7 g
6534-1	テープ押さえガイド		¥2,000-	TCE700 -60040	
	リールスタンド24		¥9,800-	TCE700 -RST24	
	リールスタンド35		¥14,800-	TCE700 -RST35 <small>TCE-800用パワーリール が必要となります</small>	
	φ32リール		¥1,100-	TCE700 -60036	
	φ35リール		¥1,100-	TCE700 -60037	

部品番号 Parts No.	部品名 Parts Name	略図 llust	定価 Price	備考 Note	重さ Weight
	パワーリール (TCE-800用)		¥4,500-	TCE80012 91111894	
7906	取扱説明書(和文)		¥350-		

その他部品

6136	剥離ローラーユニット (旧)		¥840-		60 g
6138	剥離ローラーリング (旧)		¥67-		2 g
6533	剥離ローラーホルダー ユニット (旧)		¥1,350-		66 g